

# Autodesk Revit Structure Interoperability with AutoCAD

Autodesk® Revit® Structure software is a building information modeling application for structural design, analysis, and documentation. Many structural engineering firms are familiar with AutoCAD® software and use it today for their work. This white paper introduces Autodesk Revit Structure to those structural engineers and drafters who use AutoCAD - highlighting some of the main concepts in Autodesk Revit Structure, comparing and contrasting them to familiar AutoCAD concepts, and explaining how Revit Structure and AutoCAD can be used together.

Current AutoCAD users interested in Autodesk Revit Structure and building information modeling may begin with the Autodesk AutoCAD Revit Series - Structure. This software bundle couples industry-leading AutoCAD software with state-of-the-art Revit Structure software for building information modeling. This combination protects a firm's investment in current technology and training, delivers the competitive advantage of building information modeling, and provides the flexibility to move to new ways of working based on existing workflows.

For more information regarding Autodesk AutoCAD Revit Series - Structure, please visit [www.autodesk.com/autocadrevitseries-structure](http://www.autodesk.com/autocadrevitseries-structure).

## Main Features of Revit Structure

This section presents some of the most innovative features of Autodesk Revit Structure - giving a brief explanation of the feature and then, if applicable, contrasting that feature with related AutoCAD functionality.

Features highlighted are: 3D modeling environment, structural parametric components and families, intelligent sketching tools, working with multiple design views, working without a command line or layers, multiple users accessing a single project file, reading and writing to CAD formats (such as DWG), and producing documentation sets.

### CONTENTS

**Main Features of Revit Structure ..... 1**

**Using Revit Structure with AutoCAD ..... 9**

Importing DWG Details to Revit Structure..... 9

Data Export from Revit Structure to DWG..... 16

## 3D Modeling Environment

One of the major differences between Revit Structure and AutoCAD is the use of true structural elements in Revit Structure rather than geometry. In Revit Structure, all drawings, views, schedules, and so forth, are "live views" of the underlying parametric building model. All these live views - the 3D model views, the 2D drawing sheets, sections, and plans, the informational schedules and take-offs - are all coordinated because they are all a part of the same underlying project model. As a result, users can work in any of these views, switching between them as needed.

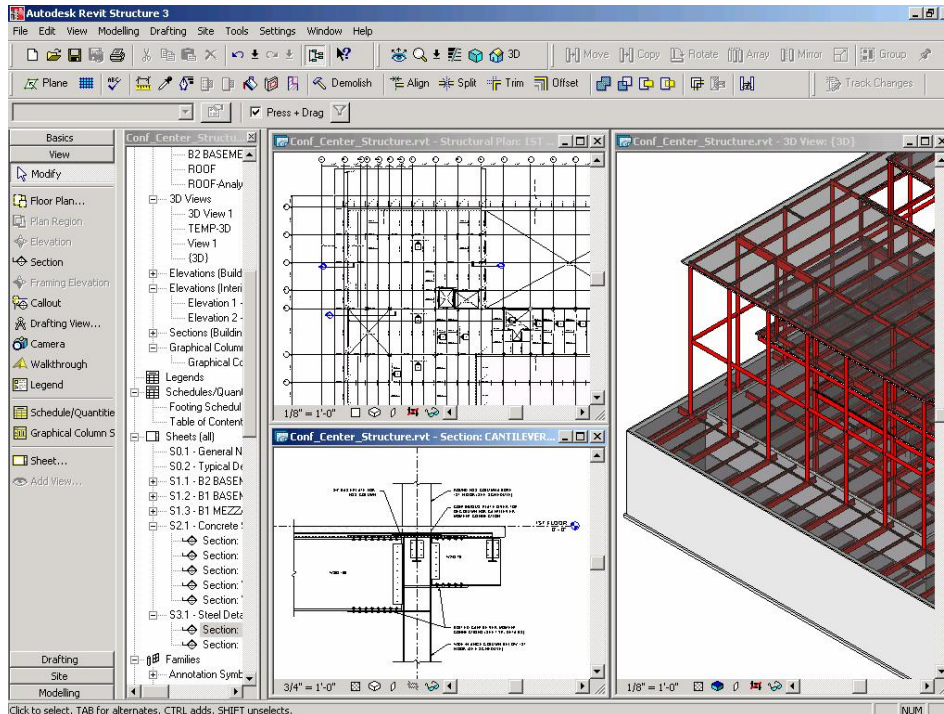

**Figure 1**

The Revit Structure model, views and drawings always stay fully coordinated.

The parametric change engine at the heart of Autodesk Revit coordinates all the changes to the structure model and automatically updates all views and documentation - increasing the accuracy and quality of the design as it evolves.

## Structural Parametric Components

Autodesk Revit Structure is a true parametric structural modeler. The modeling engine in AutoCAD contains primitive objects and requires that all custom shapes be created manually. In contrast, the Revit Structure model already contains 3D parametric structural components - such as walls, columns, and beams - used for modeling and model-based details, and 2D parametric components that are used specifically for detailing.

Revit Structure uses three types of parametric objects: (model) elements, (model) components and detail components.

## Elements

3D model elements - such as walls, beams, braces, columns, slabs, etc. - are used for both structural modeling and detailing, but also include analytical properties for structural analysis in third-party software. Because these elements are used most often in structural models, they are given their own tool in the modeling toolbar: structural column, structural

wall, beam, and so forth. These elements are visible in any view that is created in the model.

### Components

Components are a subset of 3D model elements - those elements that are not as widely used, such as concrete pile caps or double angle connections, which can be loaded into each project on a demand base. Like the other elements, they are used for both structural modeling and detailing. These elements are also visible in any view that is created in the

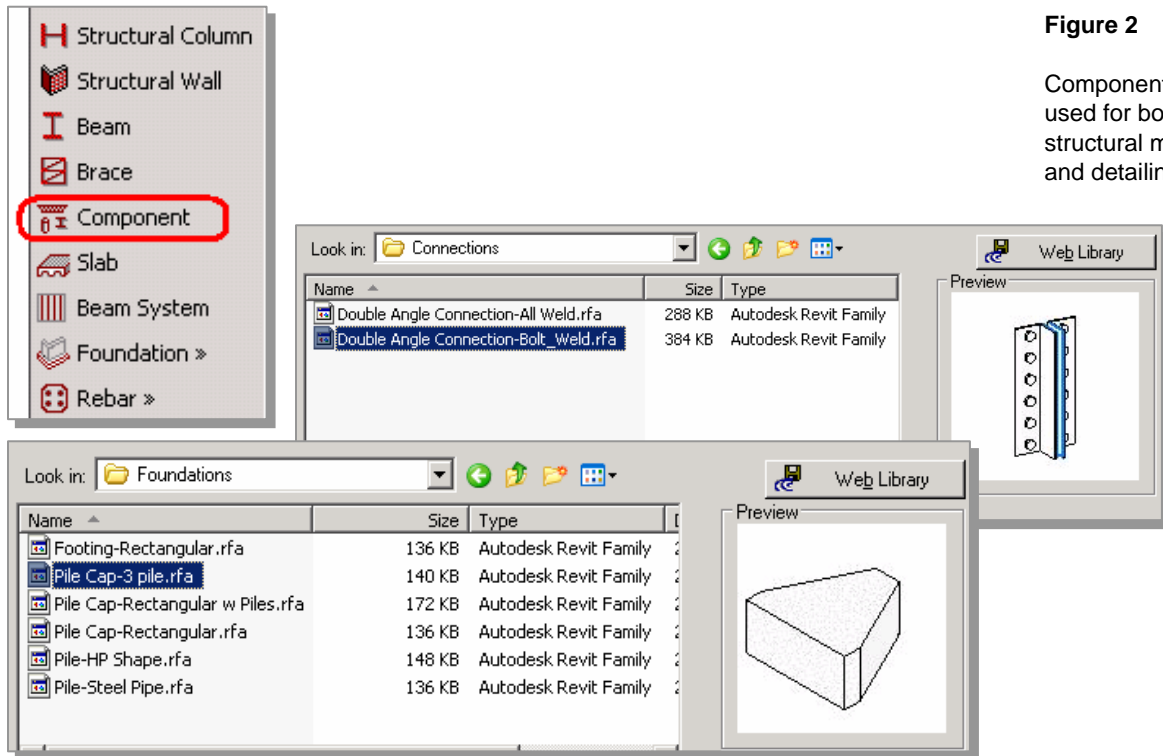

**Figure 2**  
Components are used for both structural modeling and detailing.

### Detail Components

2D detail components are similar to blocks in AutoCAD. These detail components - such as anchor bolts in footings, fasteners, plates, rebar, etc. - are used only in drafting views to complete 2D details.

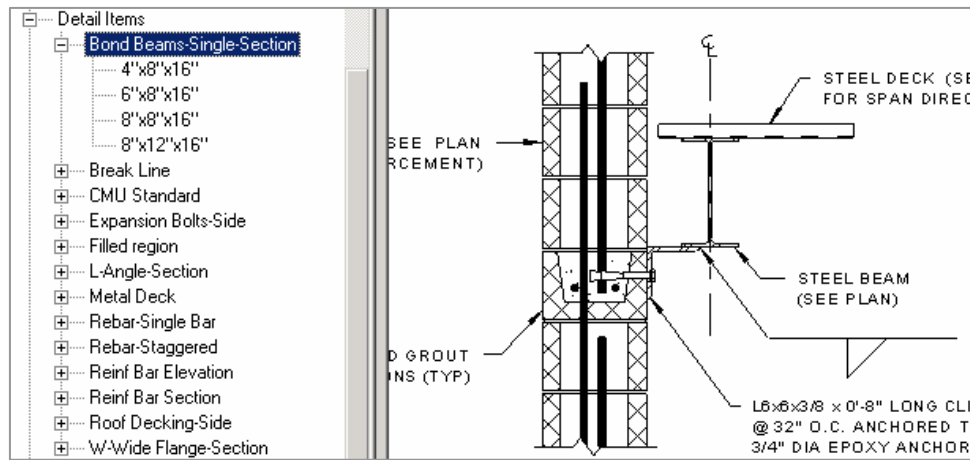

**Figure 3**  
Detail components used in a typical detail.

Revit Structure Parametric Components carry information about their relationships to other elements in the building structure - in contrast to the blocks and solids used in AutoCAD. For example, in Revit Structure, a column's properties can state that it should go from Level 2 to Level 4. After this property is set, in Revit Structure the column retains its relationship to these levels no matter what changes are made to the model (such as changing floor heights).

Dimensions always correspond to the condition or elements they are referencing and are accurate at all times. Updating a dimension automatically updates the parametric components and their relationships to other components. Locking a dimension allows a user to add a constraint to an element's geometry or to set geometric relationships between elements. After a dimension is locked, Revit Structure maintains this dimensioned relationship.

Dimensioning and alignment locking in Revit Structure allow the designer to place building components in relation to others - and keep it that way throughout the design - thereby preserving design intent. Components may be locked together in more than one place to preserve wall alignments, and columns and beams placements while the model is being altered in other areas. Component relationships may be constrained and overridden at the designer's discretion. Dimensions may be locked or editable while the parent elements behave accordingly. Because elements can be aligned and locked into place, many repetitious editing commands are eliminated, allowing for faster work and fewer errors.

Dimensions in schedules behave the same way. A user can change width and height values in the elements of the model and the existing schedules will be updated with revised size. The behavior is the same if the changes are made in the schedule as well. Coordination of dimensions and graphics is assured everywhere.

## Families vs. Blocks

AutoCAD users are accustomed to storing symbols as blocks in individual DWG files. Autodesk Revit Structure stores similar parametric components in family files. Family files can contain many styles of components allowing for easier organization and data sharing. These customizable families used by Revit Structure offer more placement options than the single insertion point used by AutoCAD blocks and xrefs.

Revit Structure comes with many structural components built right into the product, including walls, beams, footings, etc. These are commonly referred to as "objects" in products such as Autodesk® Architectural Desktop software. The families and structural components in Revit Structure offer higher levels of customization and functionality. Users can modify alignment planes and add subcategories to their components. Another unique capability in Revit Structure is the ability of users to create their own intelligent parametric components, or quickly and easily customize the ones included within the Revit Library.

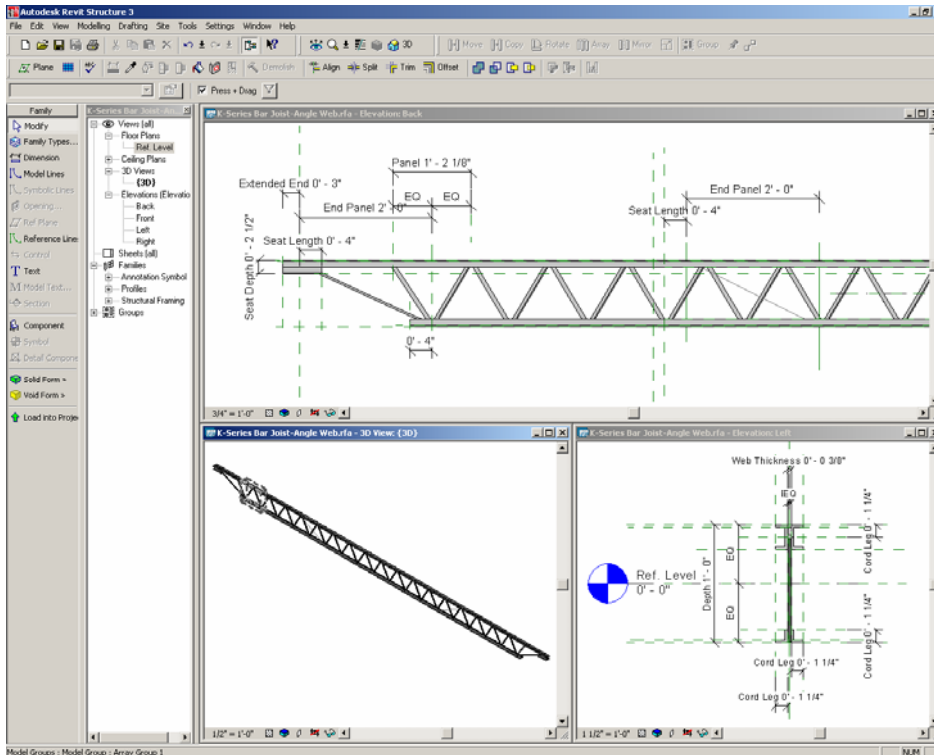

Figure 4

Revit Structure includes “out-of-the-box” parametric components, such as this open web joist family, that users can modify as needed.

## Alignment vs. Osnaps

Autodesk Revit Structure offers AutoCAD users new sketching tools like Temporary Dimensions and Alignment Guides. Alignment guides are similar to the Object Tracking feature in AutoCAD. Temporary line and arc extensions as well as other useful snap points relative to a user's current position in the model appear as aids during design. Whether a user is sketching new elements in the family editor or inserting components in a view, the appropriate dimensions and guidelines assist placement in the Revit Structure model and is based on the context of the modeling operation. In contrast, the osnap feature of AutoCAD snaps to any entity that fits the current osnap settings.

With Revit Structure, the structural designer can quickly place walls, columns, and other components correctly with the option to easily modify their location later.

## Multiple Design Views

Autodesk Revit Structure makes extensive use of various views of the parametric building model.

Revit Structure allows the structural drafters and engineers to work with components in any view - be it plan, elevation, section, or perspective - or from within a schedule (an informational view of the model so to speak).

Each type of view may be opened at the same time, side by side, and any changes made in one are immediately updated in all other views. Users see the effects of a design change immediately ripple through the model, without worrying about manually coordinating that change in multiple views.

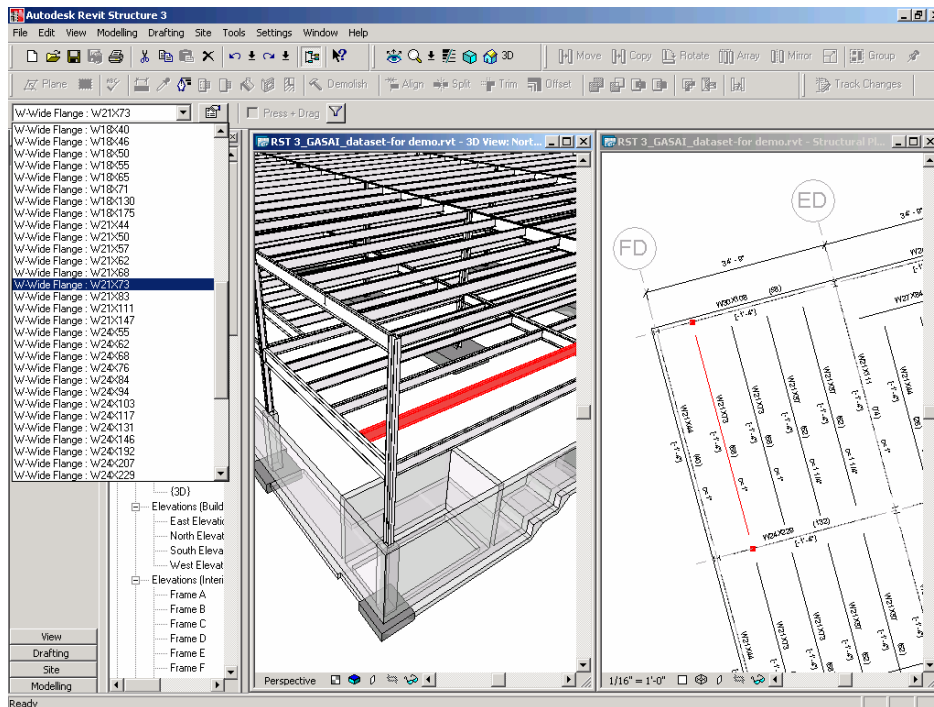

Figure 5

Changes made in any view are immediately reflected in all other views.

The 3D building information model and its multiple design views lead to better communication within the structural team itself and between the structural design team, their client architects, and the contractors.

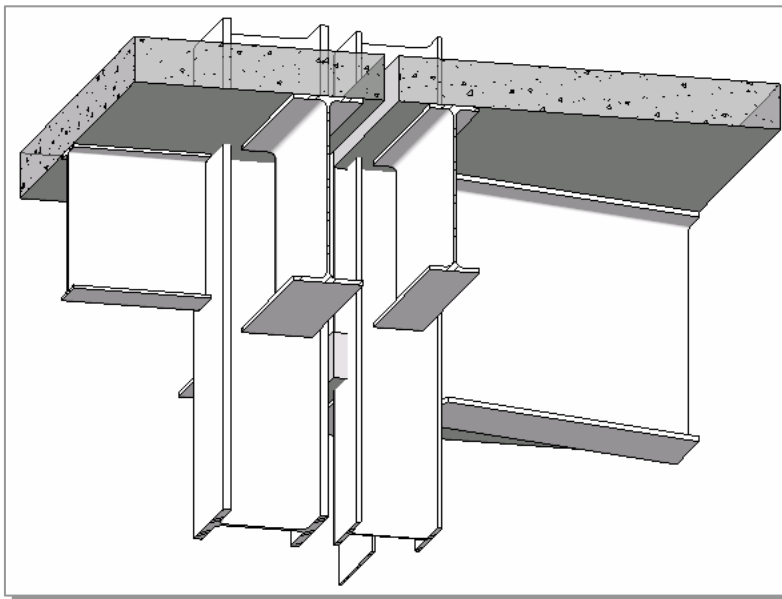

Figure 6

3D model representations are particularly useful when geometry gets complex.

Users can easily create their own views such as structural plan views fully associated with the corresponding levels.

In a mouse click, automatic views are created from the model by just placing an elevation or section tag on the floor plan. As the model progresses, Revit Structure automatically generates standard views including elevation and section views, and users can easily create their own 3D camera view of the building. Users can also alter the display of the elements in any view by choosing "wireframe," "hidden line," "shaded," or "shaded with edges display."

## No Command Line or Layers

Two instantly noticeable differences between Revit Structure and AutoCAD are the absence (in Revit Structure) of a command line and layers. The Revit Structure user interface has neither a command line or a layer control feature. All structural tools and components are presented on a single, easy-to-use toolbar. Structural drafters stay more focused on the model rather than the keyboard and command line. Layers are not needed to control the visibility of components. Their visibility are controlled through the Category Visibility feature which works on a per-view basis, comparable to the AutoCAD Freeze/Thaw/On/Off by viewport feature. Color and line type are also controlled by category.

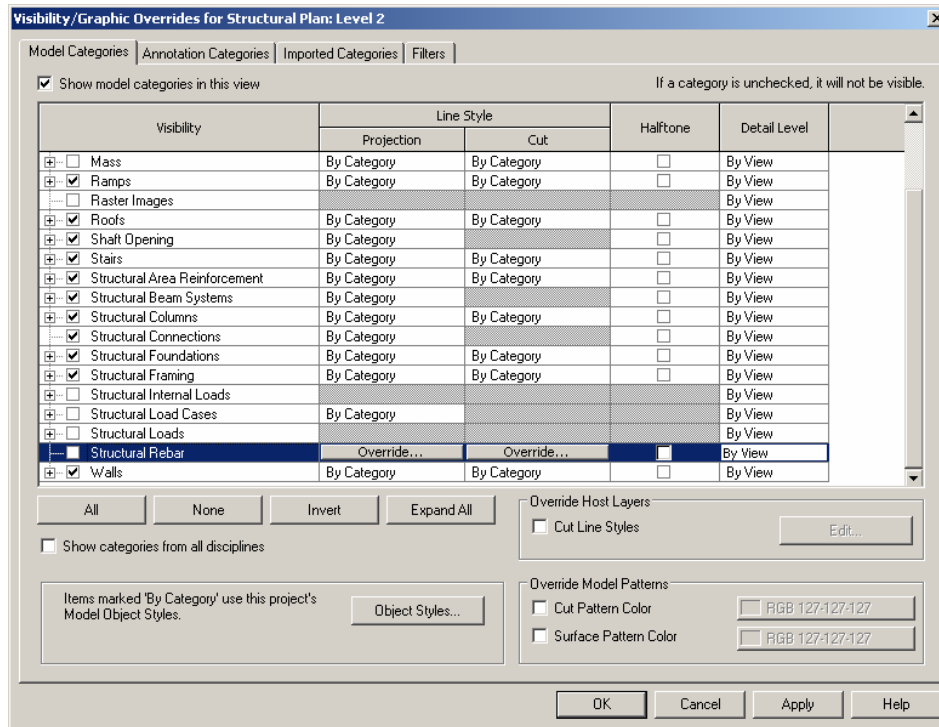

Figure 7

The visibility table allows structural drafters to turn on and off some structural objects and annotations before printing.

In addition, components in Revit Structure "know" how to display themselves depending on the view in which they are seen. For example, framing elements only display in stick representation with automatic cutback in plan views, while all geometry is shown in a 3D isometric view. Braces display object geometry in elevation and 3D views while only symbol in dash lines are shown on floor plans.

In Revit Structure, users assign a specific scale to each view that is created. Scale management in Revit Structure is much easier than traditional CAD systems, which use both paper scales and model scales.

## Single file, Multi-User projects

AutoCAD users are accustomed to storing and retrieving project data from multiple files. In Autodesk Revit Structure, all project data is stored in the single Revit Structure project file. This eliminates the need to work with external block and xref management. Revit Structure allows multiple users to work on the same project file and merge their changes with every "save," or work on their own versions of the file and then merge changes at any point in the design (see white paper on *Multi-user Collaboration with Autodesk Revit Structure Worksharing*).

Revit Structures users navigate through the various views, sections, elevations, details, schedules, and drawing sheets of a structural project using the Project Browser. This Project Browser provides convenient access to all the project information from a single location - reducing the time needed to manage project content. The organize of the Project Browser's Views and Sheets sections can be rearranged to match a desired project organization.

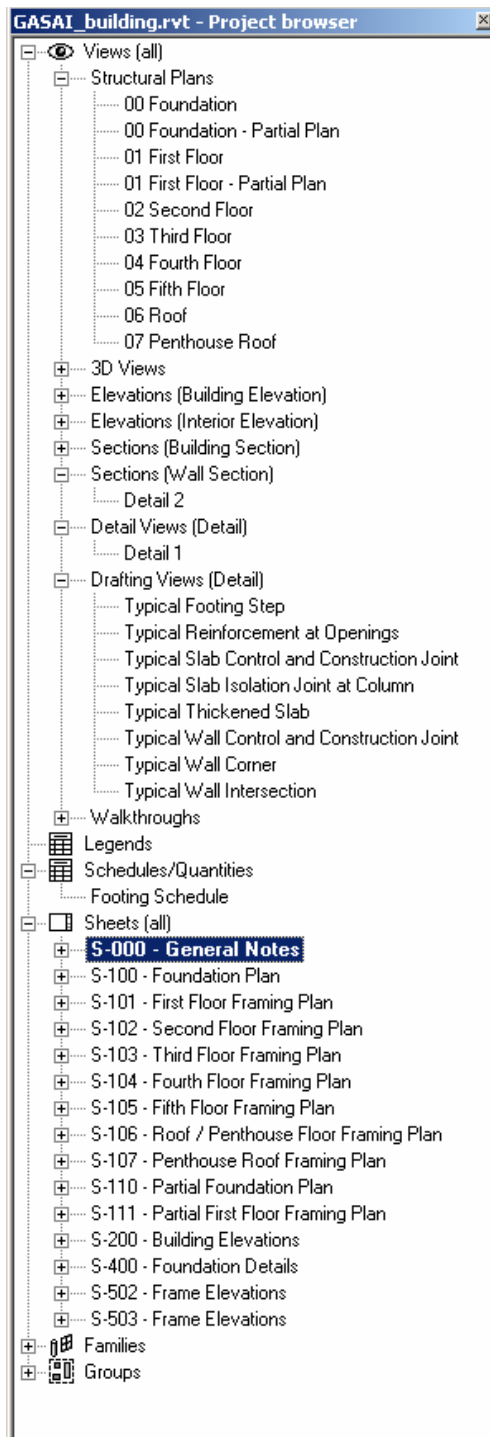

**Figure 8**

Revit Structure users navigate through a project with the Project Browser.

## Read/Write DWG

Autodesk Revit Structure provides industry-leading DWG compatibility using the RealDWG™ toolkit, and is interoperable with AutoCAD software. Revit Structure can import and export models to DXF™ and DWG formats. When exporting, Revit Structure matches its components and their subcategories from the current view to either industry standard or user defined layer names. Revit Structure can also import these formats into 2D or 3D views.

## Producing Paper Drawings

Because drawings are the critical output of the design process, Autodesk Revit Structure enables users to quickly produce accurate, detailed construction documents. All drawings are live views of the underlying parametric building model - the same model used during the design process. Therefore, any changes to the design are always updated in the drawing sheet views. Changes to elevations, sections, and callouts are immediately updated in all reflected views.

Any view of the model can be added to a sheet and properly scaled. Once placed on the sheet, Revit Structure allows the drafter to work just as easily in a sheet view as in a model view to perform any last minute placements. Scale-dependent line weight and scale-independent annotation size allow the reuse of information in views without complex reformatting. This greatly reduces the overhead coordination and file management efforts. The display on the screen is what is output to paper - letting the user "see" the final result before actual plotting, thereby reducing the amount of plotting errors. Finally, the plotter hardware support in Revit Structure is limited only by the operating system. If there is a Microsoft® Windows® driver for a plotter, Revit Structure can use it.

# Using Autodesk Revit Structure with AutoCAD

This section gives step-by-step instructions for importing AutoCAD DWG-based material into Autodesk Revit Structure as well as exporting views, details, or sheets from Autodesk Revit Structure to AutoCAD.

## Step by Step: Importing DWG Details to Autodesk Revit Structure

The steps in this section show how to import/link existing DWG details to an Autodesk Revit Structure project. Start by opening an existing Revit Structure project file, or creating a new project file and setting up views and sheets for the project. Then:

1. Create new drafting views as placeholders for imported typical details.
2. Import DXF/DWG details (typical details) created in AutoCAD.
3. Place them on sheets.
4. Save them to a Detail Library to reuse in another Revit Structure project.

## Step 1: Create Drafting Views for the DWG Files

To import or link an AutoCAD detail, the user creates and names a new drafting view in Autodesk Revit Structure.

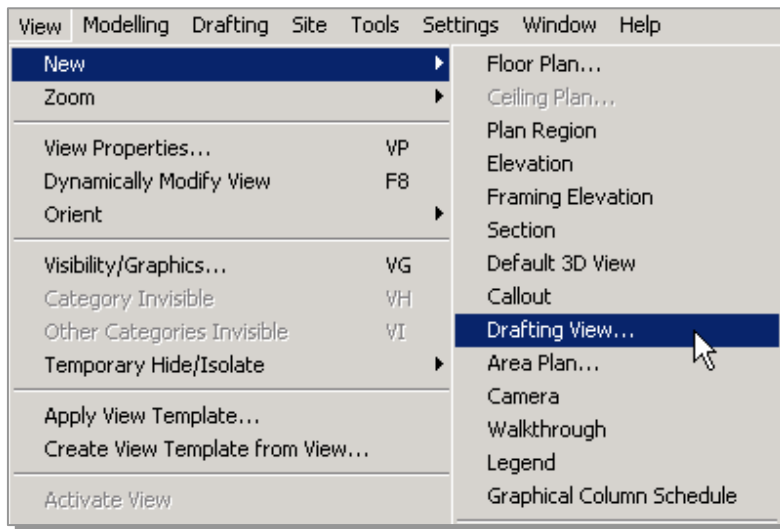
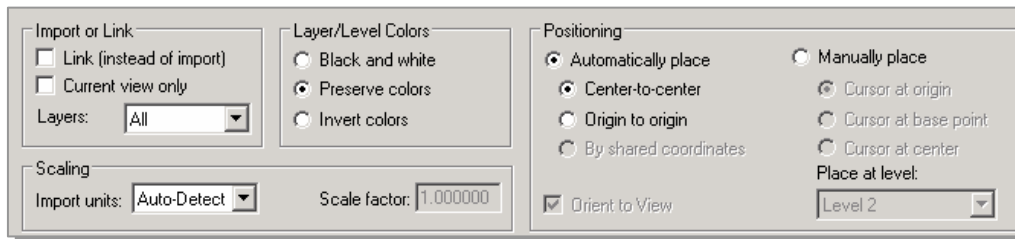

**Figure 9**

Create new drafting views as placeholders for imported typical details.

## Step 2: Import or Link the DWG Files

After the drafting view has been created, either import or link the external file. Open the new drafting view, and on the File menu, click Import/Link > CAD formats. Select the Preserve colors and the Center- to-center options for the best performance.



**Figure 10**

Revit structure users can control the importing or linking of CAD files in a variety of ways.

**Import:** When a file is imported, the data is embedded in the Autodesk Revit Structure project. Import is recommended if a user plans to migrate most details from AutoCAD to Revit Structure and then modify those details using Revit Structure.

**Link:** When a file is linked, the Revit Structure project file is smaller and the linked file can still be modified in AutoCAD. Revit Structure automatically gets the most current version of the linked file whenever the project is opened or the link is reloaded. Link should be used if details will still be developed and managed in AutoCAD.

Import DWG files choices:

- **Black and White:** Ignores color information in the external file and displays linked data as black and white vectors.
- **Preserve Colors:** Preserves the layer or level color settings in the external file.
- **Invert Colors:** Inverts the colors in the linked file, making them easier to see. If a black background is used in AutoCAD, colors may not be appropriate on a white background in Revit Structure.

Positioning choices: (note: correct alignment is best assured by selecting Automatically place in the Import/Link dialog box).

- **Automatically place:** Select one of these options for automatic placement:
  - Center-to-center: Aligns the center of the linked or imported file to the center of the Revit Structure view. Use this option when external data is offset from the origin of the drawing.
  - Origin to origin: Aligns the origin of the imported or linked file to the origin of the Revit Structure view. Use this option when relinking DWG files originally created in Revit Structure.
  - By shared coordinates: Acquires origin for use with Revit Structure files. Use this option when linking multiple buildings together that need to maintain a relationship to each other, or when linking a number of building files together with a site plan.
- **Manually place:** If offsets and dislocations were introduced during the process, or to link a detail into a drafting view, these options help position the data that is externally linked:
  - Cursor at origin: The linked file appears attached to the Revit Structure cursor at its origin. This is the typical option to manually place data.
  - Cursor at base point: The linked file appears attached to the Revit Structure cursor at its base point.
  - Cursor at center: The linked file appears attached to the Revit Structure cursor at its graphic center point. This option is helpful when handling widely displaced data.
  - Place at level: The linked file appears attached to the designated Revit Structure level.

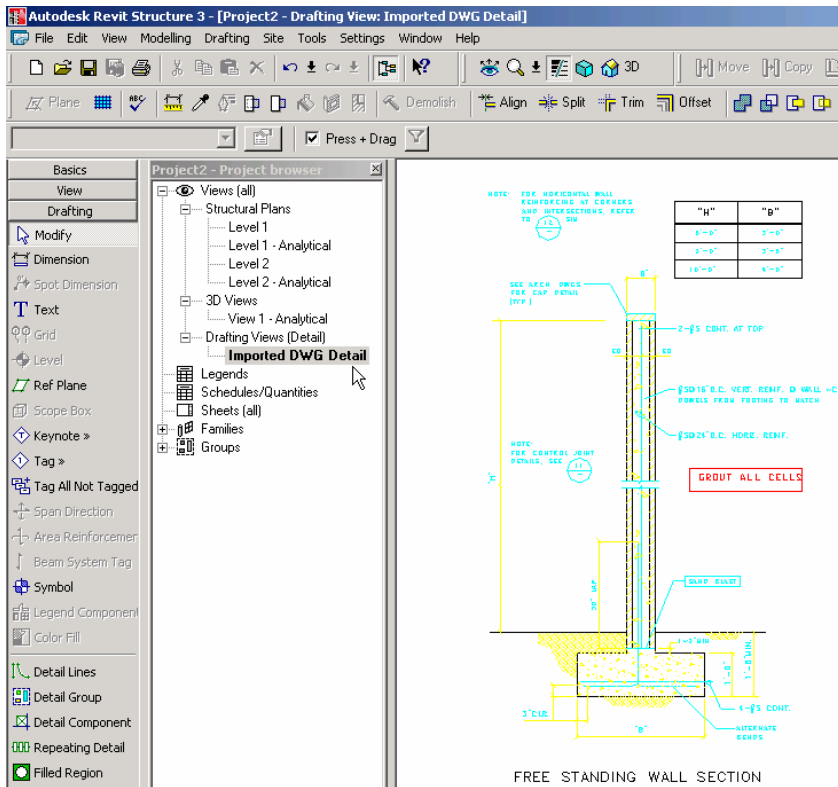
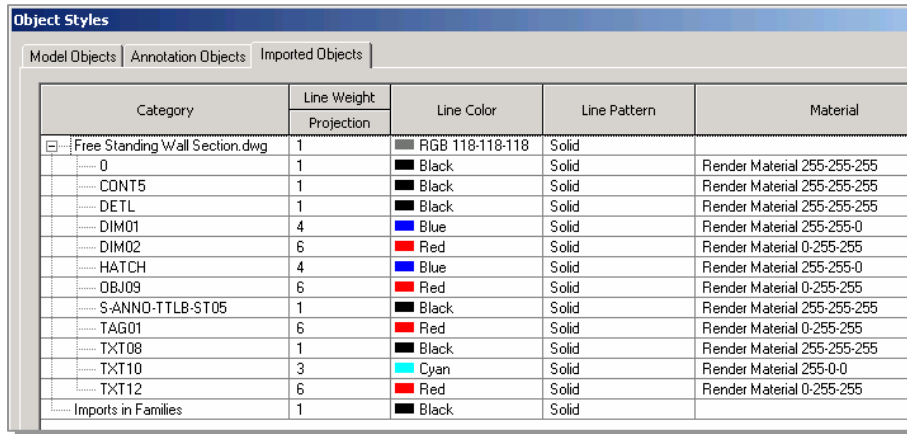

Figure 11

Imported DWG detail in new Revit Structure drafting view.

**Controlling the appearance of linked/imported data:**

The appearance of imported data is managed using the Imported Objects tab in the Object Styles dialog box. On the Settings menu, click Object Styles. Users can control the line weight, line color, line pattern, and the material for each layer or level in the linked file.

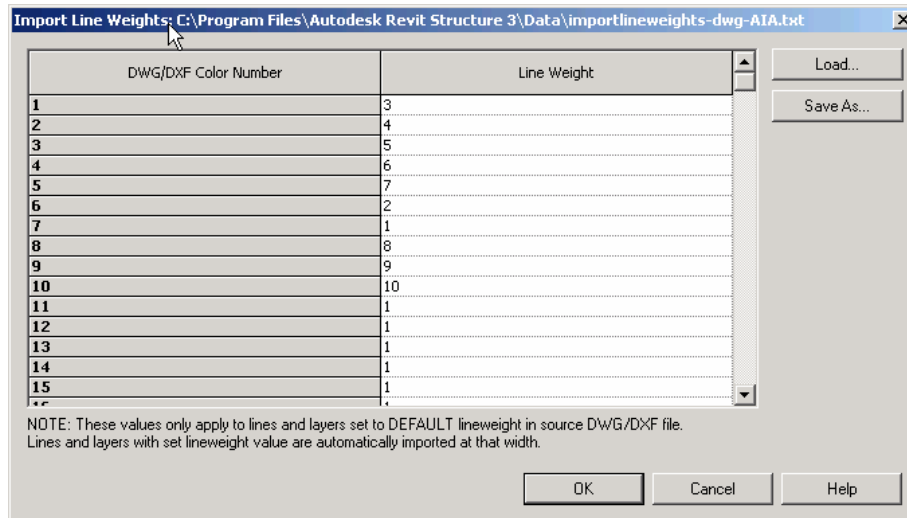

**Figure 12**

The Object Styles dialog box allows users to control the appearance of imported data.

**Specifying line weights in linked or imported drawings:**

Users can specify line weights in imported files. On the File menu, click Import/Export Settings, and then click Import Line Weights DWG/DXF. This dialog box coordinates color mapping in linked files to Revit Structure line weights. The mapping can be saved to or loaded from an external text file.



**Figure 13**

The Import Line Weights dialog box coordinates color mapping in linked files to Autodesk Revit line weights.

Users can review Revit Structure line weight settings by clicking Line Weights on the Settings menu. Note: Because Revit Structure line weights have different widths at different scales, many imported colors may map to a single line weight.

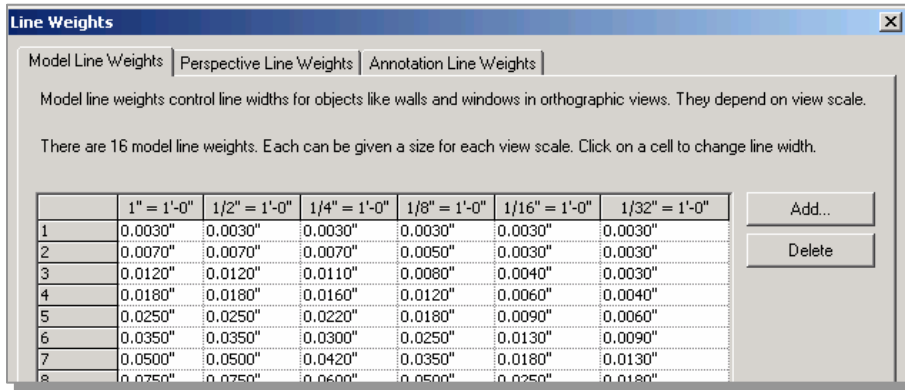

Figure 14

Autodesk Revit line weights have different widths at different scales.

**Controlling the visibility of entities in imported files:**

Users control the visibility of entities in imported files using the Visibility/Graphic Overrides dialog box. On the DWG/DXF/DGN Categories tab, users can specify visibility by layer for entire imported files or for all imports as a whole.

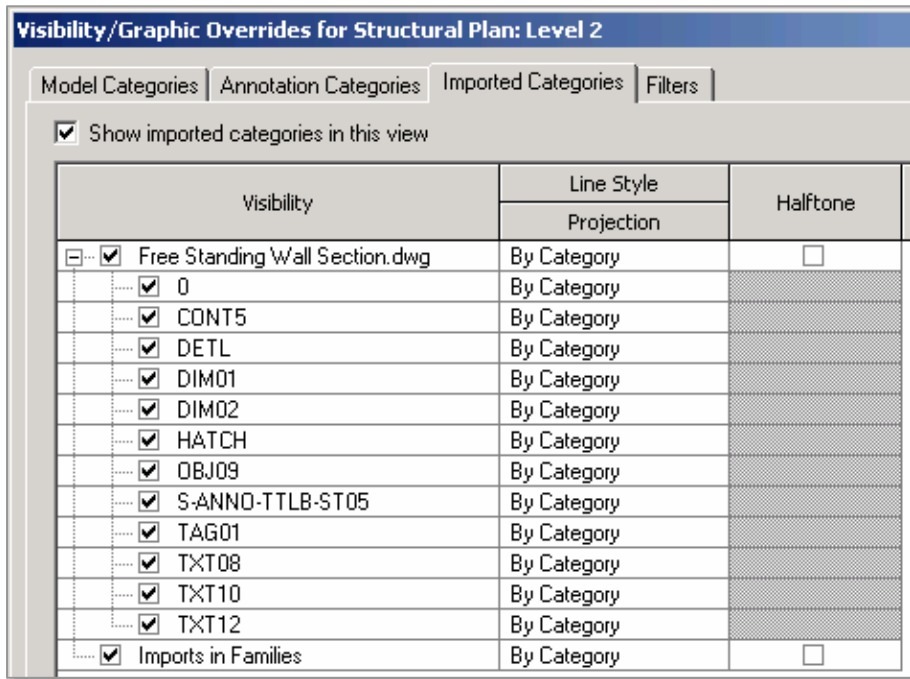
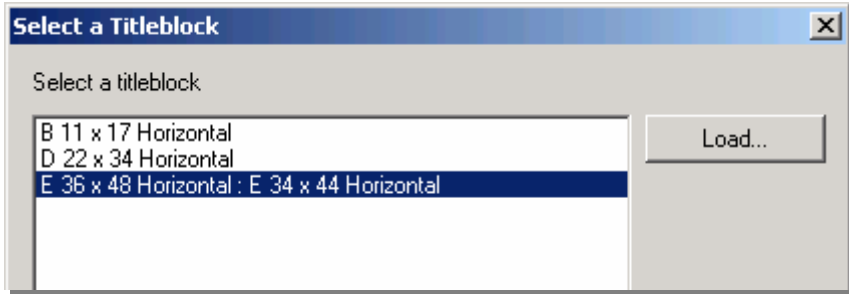

Figure 15

The Visibility/Graphic Overrides dialog box allows users to control the visibility of entities in imported files.

**Step 3: Place the Details on a Sheet**

After arranging the individual detail files in drafting views, open an existing sheet or create a new sheet for the details. On the View menu, click New >> Sheet. In the Select a Titleblock dialog box, select the desired titleblock.

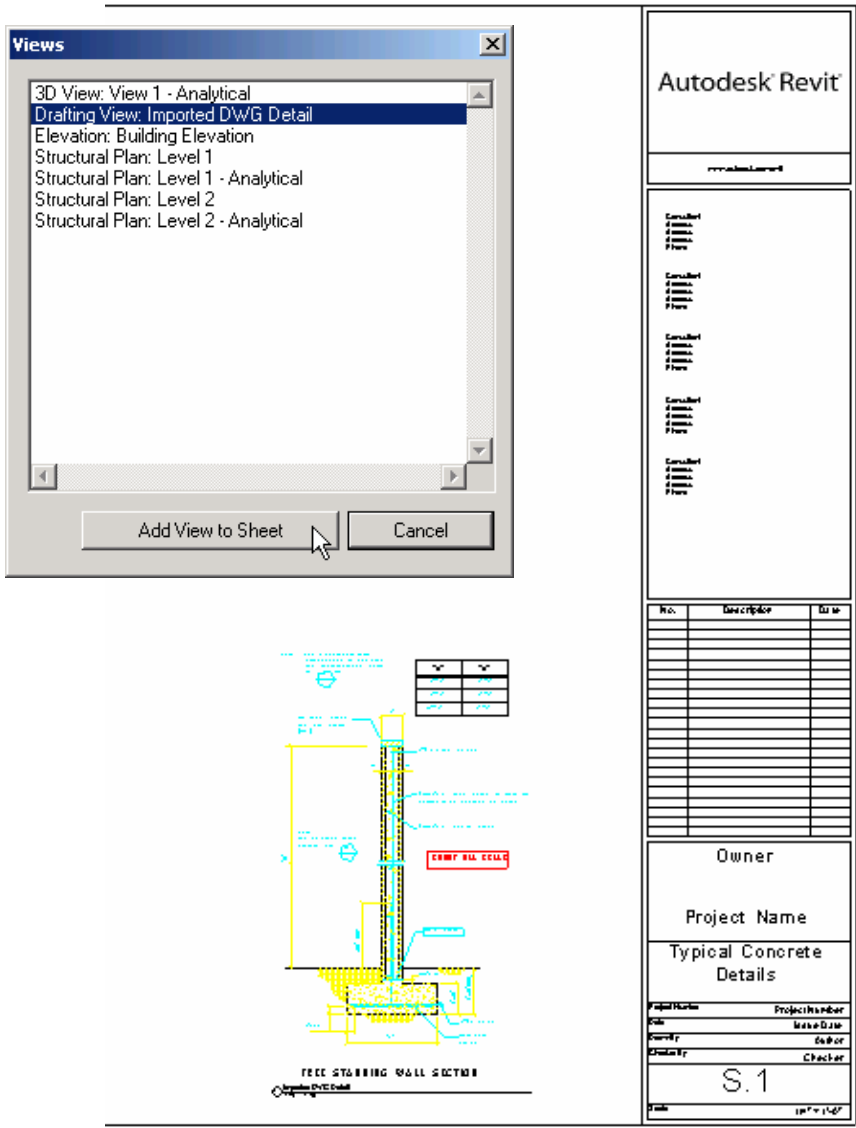

**Figure 16**

Place the newly imported detail on a new sheet and select a titleblock for the sheet.

After the sheet is created, place the drafting views in the same way all views are created in Autodesk Revit Structure:

- 1) Drag the desired views from the Project Browser onto the sheet or,
- 2) From the toolbar, click View >> New >> Add View, then select the desired view.



**Figure 17**

Place the drafting view with the imported detail on the new sheet. Then the DWG detail becomes part of the Revit Structure documentation set.

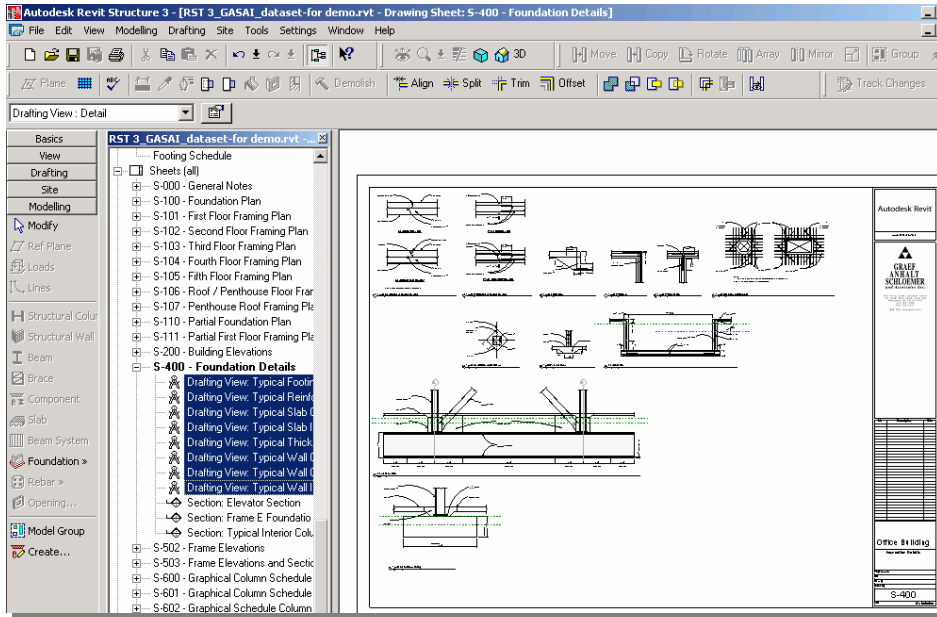

Figure 18

Several DWG details have been imported in separate drafting views and then placed onto a sheet. The project browser conveniently display the list of drafting views for that Sheet. This list can be expanded or collapsed by the user.

In the same way users can import individual details, users can also import a whole sheet of details in a DWG file directly into a Revit Structure sheet. This works well for typical detail sheets that do not need to reference any specific model view.

When some details need to reference model views, it is recommended that each individual detail be saved as a separate drafting view instead of imported as a group on a sheet.

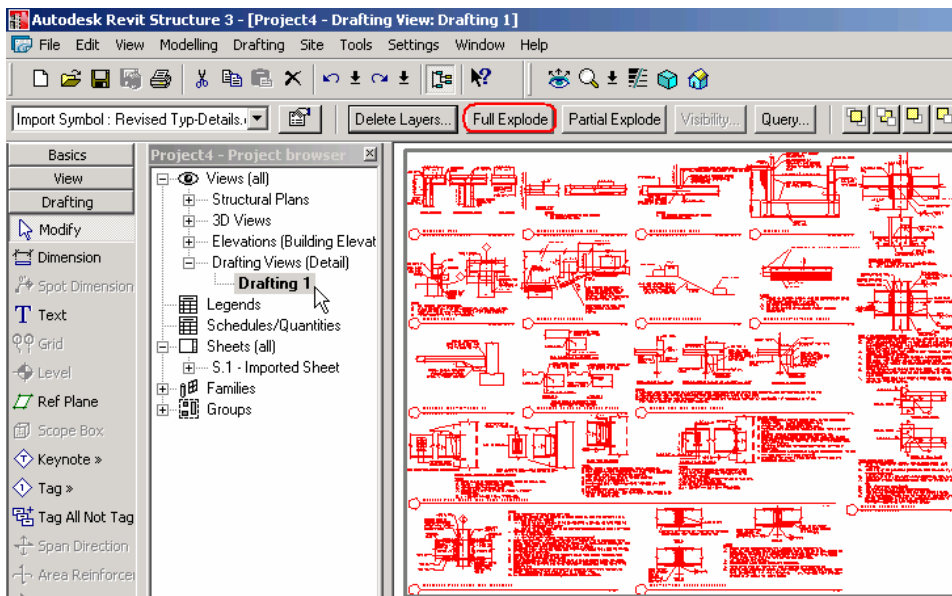

Figure 19

Import the sheet in a new drafting view. Then use the Explode tool to be able to save each detail in a separate drafting view.

This procedure may seem more time consuming but does enable that the imported AutoCAD details to be properly referenced to the project views.

The user can then just drag and drop all the details onto the new Revit Structure sheet. Detail numbers and titles can be changed to stay consistent with new project views.

### Step 4: Save to a Detail Library or Reuse in other Revit Structure Projects

To help structural drafters smoothly migrate from AutoCAD to Revit Structure as a complete documentation tool, all imported DWG details can be maintained and managed with Revit Structure. The key tool in this process is the ability to create a Revit Structure Detail Library composed of typical details, drawn from scratch entirely in Revit Structure or imported from AutoCAD.

Once an AutoCAD detail has been imported into a Revit Structure drafting view, it can easily be saved into a Detail Library file.

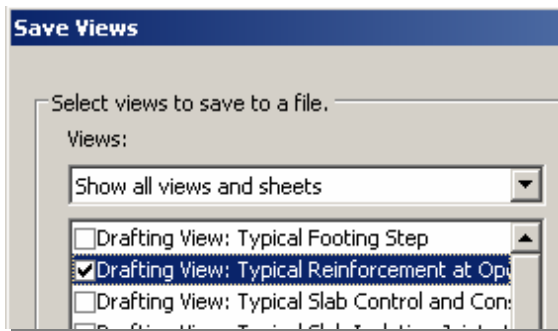

**Figure 20**

To save typical details and drafting views from an existing project to a Library file, go to File > Save to Library> Save views. Pick the drafting views you need.

Imported details can also be conveniently reused in other projects, directly from the project browser.

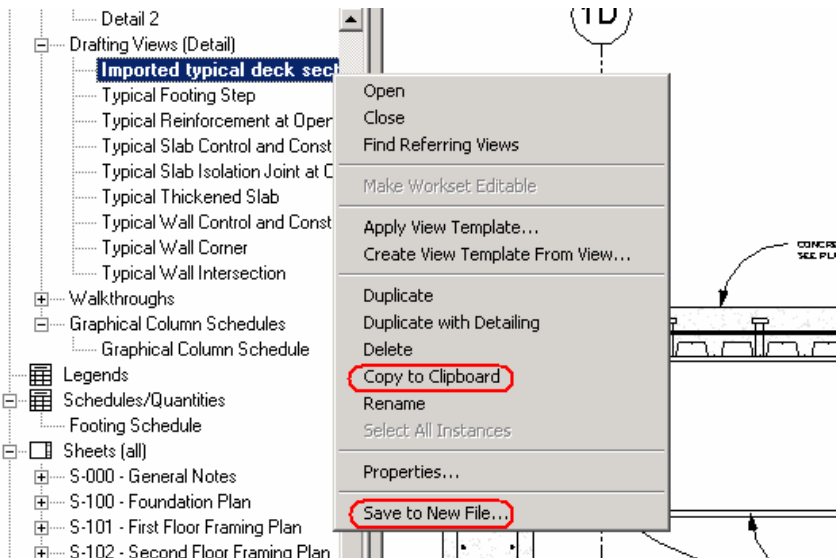

**Figure 21**

Typical details and drafting views can be reused in other projects with the Copy/Paste tool or “Save to New File” option.

### Data Export from Autodesk Revit Structure to DWG

This section offers users advice and guidance when exporting views, details, or sheets from Autodesk Revit Structure to AutoCAD. The general process is:

- Create the building model in Revit Structure.
- Set up views and sheets for the project.
- Create model-based and non model-based details. Place them on sheets.
- Export views, details, and sheets to DWG.

When preparing to export views or sheets from Revit Structure to DWG format, users should consider; export methods, file naming conventions, data export options, and layering standards.

## Exporting Views or Sheets

Users can export either views or sheets, depending on the scope of work to be done in AutoCAD, as well as the progress of construction documentation in Revit Structure.

Exporting a view creates a DWG or DXF file of the currently selected Revit Structure view. All external data linked to the view will be embedded as a block in DWG or DXF format. Use this method to annotate only selected views in AutoCAD.

Exporting an entire sheet from Revit Structure produces a set of DWG or DXF files. One file contains sheet information (borders, title block) with a viewport for each view. Each Revit Structure view becomes an individual file referenced into the sheet file and displayed in the appropriate viewport. All files are located in the same directory to facilitate tracking and management.

## Naming Conventions

To keep file names consistent throughout the project, use the Autodesk Revit default naming convention, as shown here:

- **Exported Views (not on sheets):**  
[Project Filename]-[Revit Extension]-[View Category]-[View Identifier].[Extension]
  - **Exported Views (on sheets):**  
[Project Filename]-[Revit Extension]-[View Category]-[Sheet Number]-[Sheet Name]-[View Identifier].[Extension]
  - **Exported Sheet:**  
[Project Filename]-[View Category]-[Sheet Number]-[Sheet Name].[Extension]
- Project Filename: Name of the Autodesk Revit file
  - Revit Extension: Standard Autodesk Revit file extension (rvt, rft, rfa), depending on the file open in Autodesk Revit
  - View Category: Floor Plan, 3D View, Elevation, Section, Drafting View, or Drawing Sheet
  - Sheet Number: Standard sheet number
  - Sheet Name: Standard sheet name
  - View Identifier: Standard view name
  - Extension: Exported .dwg or .dxf, depending on user selection

## Data Export Options

The following options are available in the Export dialog box:

- **Export Range:** Select either the current view or a set of views/sheets. The latter facilitates a batch-like export of a range of views.
- **Export Layers File:** The file displayed by default is the current export layer standard. Users can select a different export standard as desired.

## Layering Standards

In the Export Layers dialog box, categories and subcategories of Autodesk Revit Structure host components are mapped to a layer name and color number for use in a DWG or DXF file, using settings specified in special text files in the Revit Structure\Data directory.

By default, Revit Structure uses the last-specified export layer standard. The software supplies files for the AIA, BS1192, ISO 13567, and CP 83 standards. Users can select from these or create custom standards. Users can incorporate custom office-dependent layering standards into the workflow and apply them to external files. This helps to ensure data consistency within a multi-platform environment.

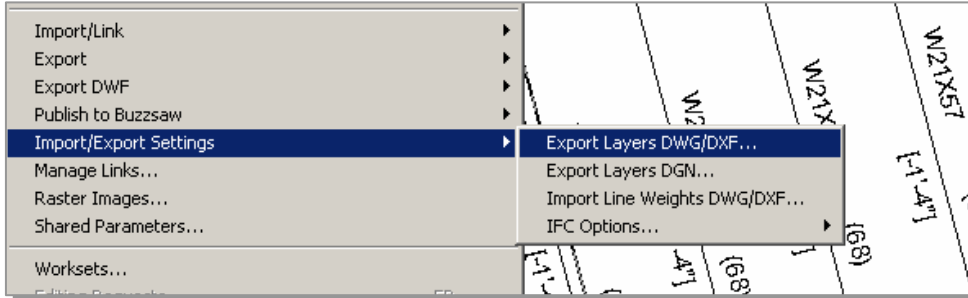

**Figure 22**

Export settings can be used to map Revit Structure components to a layer name and color number in a DWG file.

## Summary

Given the prevalence of AutoCAD within the structural community, leveraging existing digital design information embodied in DWG files is a key ingredient to a successful adoption of Autodesk Revit Structure as structural drafting and documentation platform.

Building Information Modeling gives structural firms an integrated modeling environment for design, analysis and documentation. A purpose-built BIM solution such as Autodesk Revit Structure improves a firm's productivity, accuracy and coordination in their structural design and documentation process.

The interoperability between Revit Structure and AutoCAD allows firms to realize the benefits of building information modeling while preserving their investment in AutoCAD and maintaining the flexibility to deploy AutoCAD as needed on projects. Knowing how well the two products integrate - firms can now move confidently to structural building information modeling.

## About Autodesk Revit

The Autodesk Revit platform is Autodesk's purpose-built solution for building information modeling. Applications such as Autodesk Revit Building, Autodesk Revit Structure, and Autodesk® Revit® Systems built on the Revit platform are complete, discipline-specific building design and documentation systems supporting all phases of design and construction documentation. From conceptual studies through the most detailed construction drawings and schedules, applications built on Revit help provide immediate competitive advantage, better coordination and quality, and can contribute to higher profitability for architects and the rest of the building team.

At the heart of the Revit platform is the Revit parametric change engine, which automatically coordinates changes made anywhere — in model views or drawing sheets, schedules, sections, plans... you name it.

For more information about building information modeling please visit us at <http://www.autodesk.com/bimT>. For more information about Autodesk Revit and the discipline-specific applications built on Revit please visit us at <http://www.autodesk.com/revit>.

# Autodesk®

Autodesk, AutoCAD, DXF, RealDWG, and Revit All other brand names, product names, or trademarks belong to their respective holders. Autodesk reserves the right to alter product offerings and specifications at any time without notice, and is not responsible for typographical or graphical errors that may appear in this document. Computer aided design software and other technical software products are tools intended to be used by trained professionals and are not substitutes for your professional judgment.

© 2006 Autodesk, Inc. All rights reserved.